





Made in Germany



**WT 205L *e.tronic***  
Product Information

Radius [m]		25	30	36	40	42	45	48	50	54	Load capacity [t]	
Jib length [m]	54	5.4 - 21.0	9.4	7.2	5.3	4.4	4.0	3.5	3.0	2.7		2.2
	48	4.8 - 22.0	10.0	7.6	5.6	4.6	4.2	3.6	3.1			
	42	4.2 - 25.5	12.0	9.2	6.6	5.3	4.7					
	36	4.2 - 26.5	12.0	9.7	6.8							
	30	3.0 - 28.0	12.0	10.0								
		 12.0										

The loads relate to 45m hook travel. For longer hook travel distances, the loads are reduced by the additional weight of the hoist rope (with 3 fall rope = 3.9kg/m hook travel).

Radius [m]		25	30	36	40	42	45	48	50	54	60	Load capacity [t]	
Jib length [m]	60	6.0 - 27.0	8.0	6.9	5.2	4.3	4.0	3.5	3.1	2.8	2.4		1.8
	54	5.4 - 28.5	8.0	7.4	5.6	4.6	4.2	3.7	3.2	3.0	2.5		
	48	4.8 - 30.0	8.0	8.0	5.9	4.9	4.4	3.8	3.3				
	42	4.2 - 33.0	8.0	8.0	6.8	5.5	4.9						
	36	3.6 - 34.0	8.0	8.0	7.0								
30	3.0 - 30.0	8.0	8.0										
		 8.0											

The loads relate to 45m hook travel. For longer hook travel distances, the loads are reduced by the additional weight of the hoist rope (with 2 fall rope = 2.6kg/m hook travel).

Radius [m]		25	30	36	40	42	45	48	50	54	60	Load capacity [t]	
Jib length [m]	60	6.0 - 44.0	4.0	4.0	4.0	4.0	4.0	3.8	3.4	3.1	2.6		2.0
	54	5.4 - 45.0	4.0	4.0	4.0	4.0	4.0	4.0	3.5	3.2	2.7		
	48	4.8 - 46.0	4.0	4.0	4.0	4.0	4.0	4.0	3.6				
	42	4.2 - 42.0	4.0	4.0	4.0	4.0	4.0						
	36	3.6 - 36.0	4.0	4.0	4.0								
30	3.0 - 30.0	4.0	4.0										
		 4.0											

The loads relate to 45m hook travel. For longer hook travel distances, the loads are reduced by the additional weight of the hoist rope (with 1 fall rope = 1.3kg/m hook travel).

## The WT 205L *e.tronic* tower crane. Fast. Reliable. And with a luffing jib.

### **Transport.** **Compact on the road, too.**

It's a space-saving giant, that's for sure. Which is why it is easy to load – the slewing unit as well as the 60m jib on just three trucks. And the 20' long counter jib is also fitted with container connectors, enabling it to be transported on any standard chassis. Needless to say, the WT 205L *e.tronic* doesn't need much room for storage, either.

### **Assembly.** **Full steam ahead.**

You can confidently look forward to working with the WT 205L *e.tronic*. Thanks not least to the unique roller block concept, it is quick and easy to assemble. And the assembly crane only has to lift a light load since the weight of the stay rack is kept to a minimum. Once your "new colleague" has been assembled, the current configuration is simply stored in the *e.tronic* control. To program the maximum load limit switch, you need only one known test weight.

### **Maintenance.** **Simply ingenious.**

Don't be surprised when the WT 205L *e.tronic* proves to be a partner you can count on. For reliability is ensured by tried and tested high volume components. And the sophisticated error diagnostics system not only displays any faults and malfunctions on the touch screen panel, but also allows operating and error data to be retrieved on any PC with a modem and the corresponding software. When the reservoir of the *e.tronic*-controlled central lubrication system is empty, an SMS is automatically sent to a pre-selected service number

### **Control.** **Crystal clear for best results.**

The WT 205L *e.tronic* is equipped with the *e.tronic* programmable logic control system, featuring 230 V powerful relay switches which are rated category AC 4 – so operational wear and tear is not an issue here. The safety-related measuring systems are fitted in duplicate and thus ensure that DIN EN 954/3 is complied with. And what's more, since the frequency converter controlled absolute encoders are identical for all drives, they are completely interchangeable.

The spacious, side-mounted operator cab ensures the crane operator is comfortable and has clear visibility. It also features a touch screen panel which provides him with all the important data he requires – in the language of his choice, of course.

### **Modular system.** **Make yourself comfortable.**

From 30m to 60m – just adapt the length of the jib as required, with five different jib pieces in six metre lengths. The slewing unit can be assembled on the 2m wide tower elements, which have a standard length of 6.5m and feature external and internal climbing frames. Additional tower elements in intermediate lengths as well as base elements such as foundation anchors, expandable cross frames and assembly optimised cross frame elements – with pressure plates that can be replaced by rail-going undercarriages – are also available for flexible use. And as far as advertising is concerned, the two illuminated display boards can be changed quickly and easily – simply remove the diffusing panel and change the logo.

The real size of the WT 205L *e.tronic* is demonstrated by its maximum freestanding tower height of 71.30m, realised with standard tower elements. Higher freestanding under hook heights are possible with special tower elements. Just ask!

# WILBERT Tower Cranes Layout drawing



60.2m

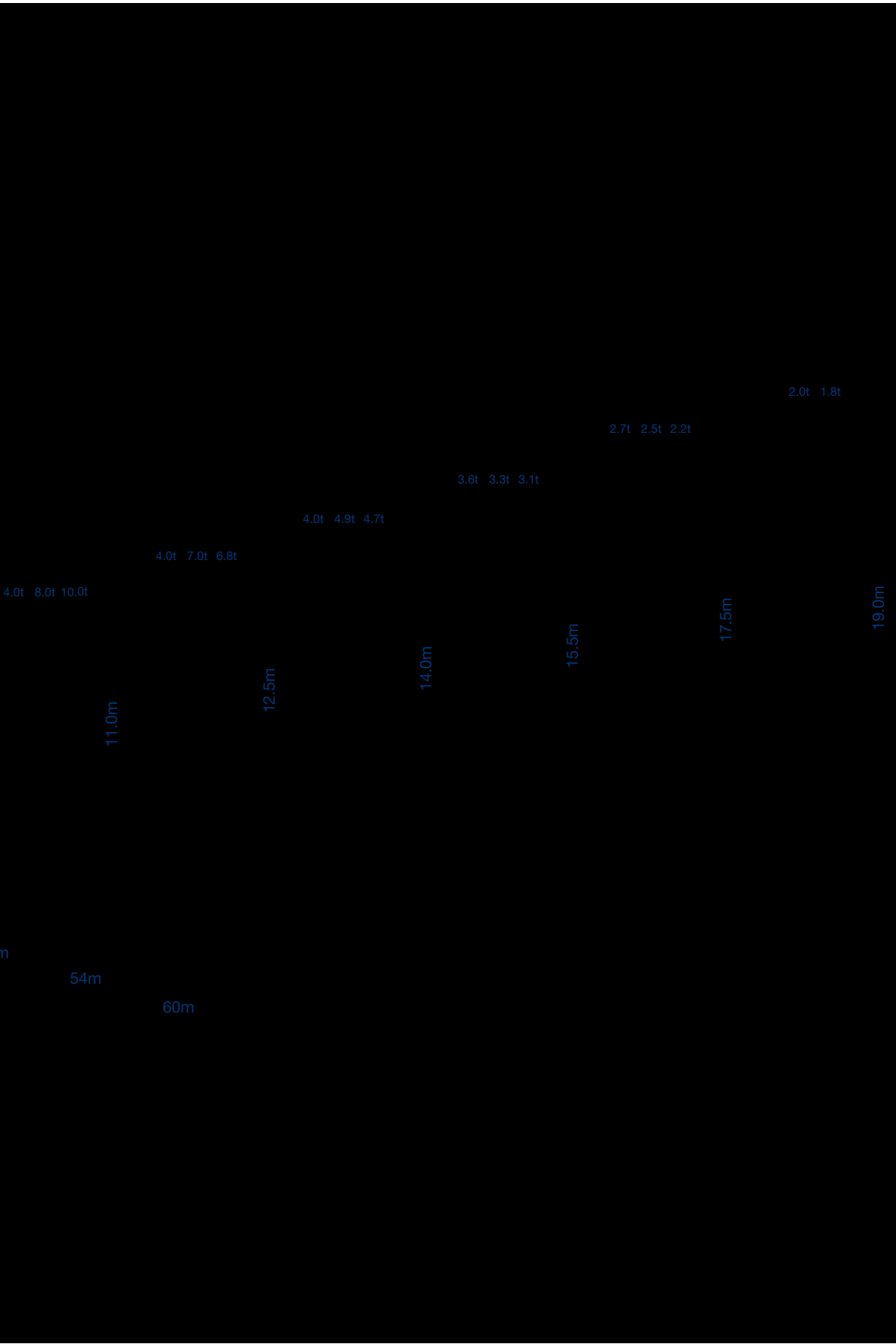

2.0t 1.8t

2.7t 2.5t 2.2t

3.6t 3.3t 3.1t

4.0t 4.9t 4.7t

4.0t 7.0t 6.8t

4.0t 8.0t 10.0t

11.0m

12.5m

14.0m

15.5m

17.5m

19.0m

54m

60m

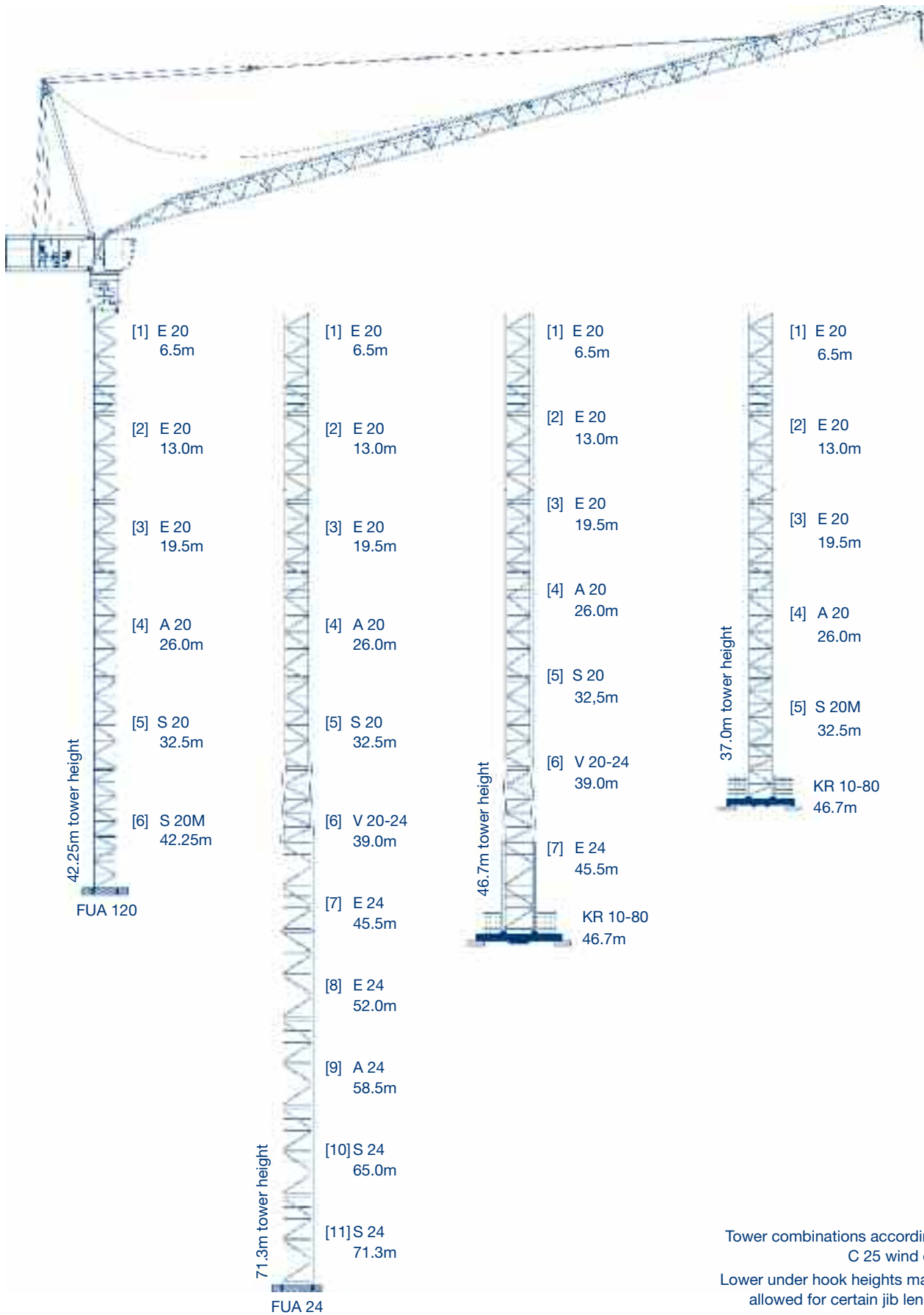



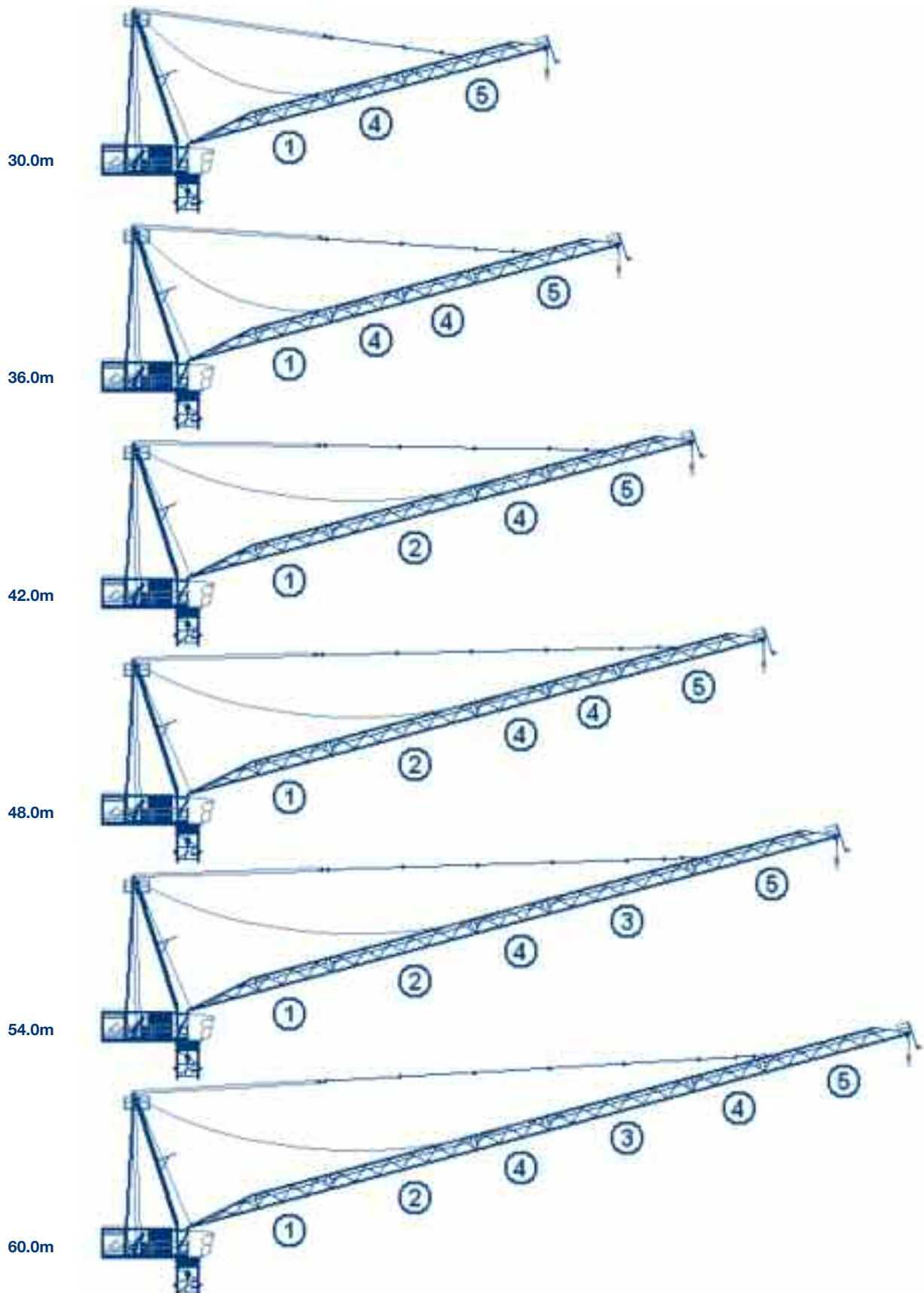

Tower combinations according to C 25 wind data.  
Lower under hook heights may be allowed for certain jib lengths.

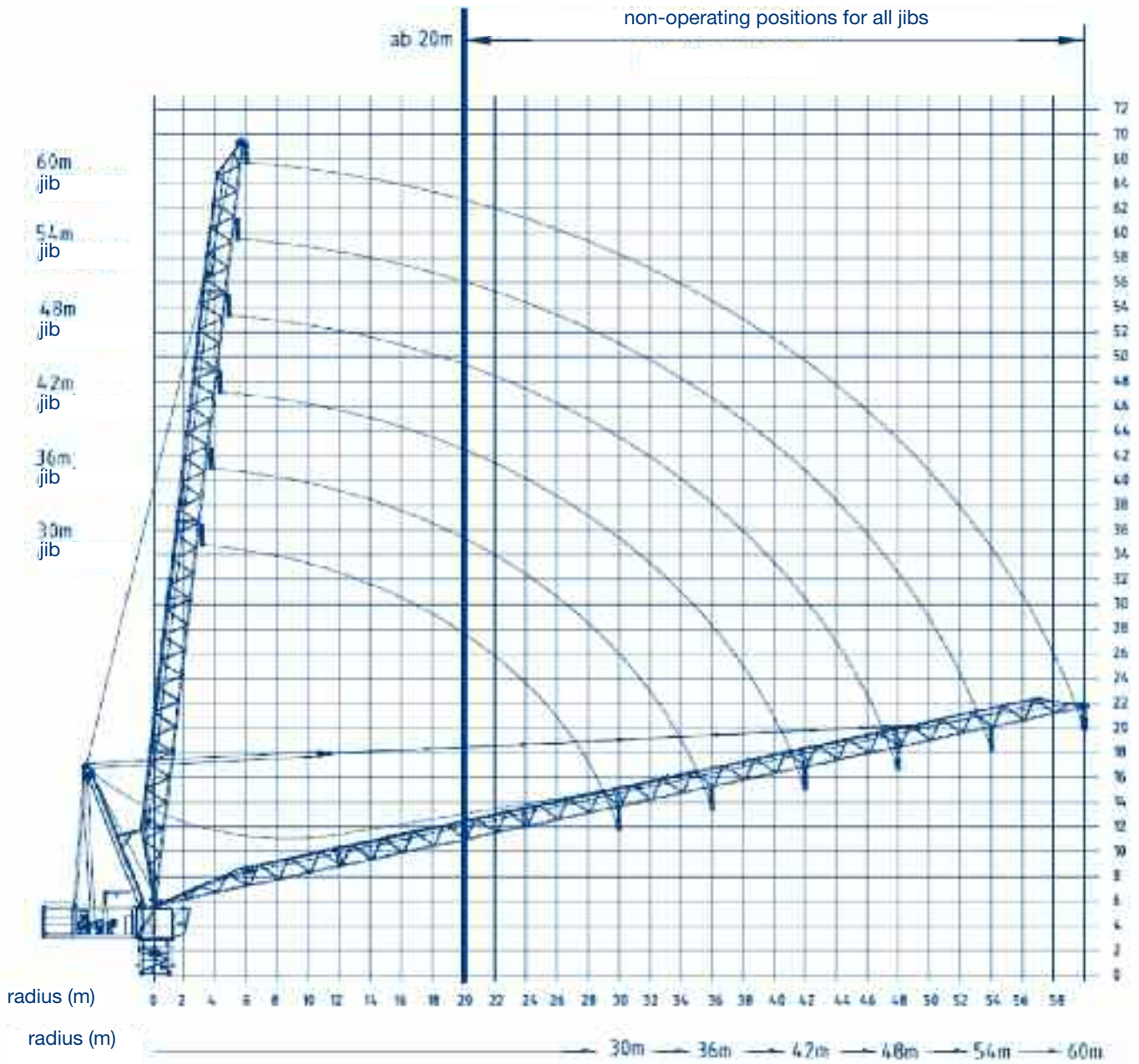



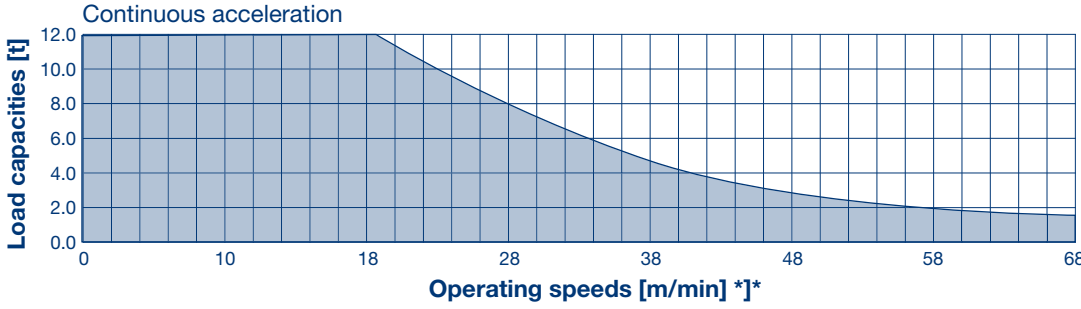
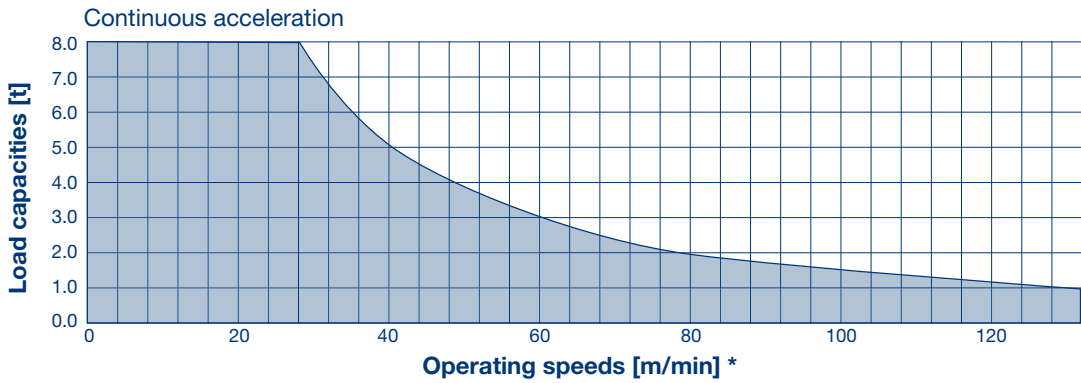

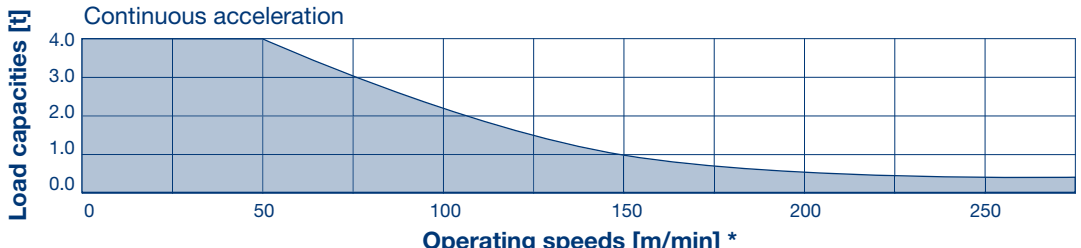
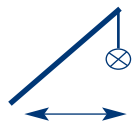
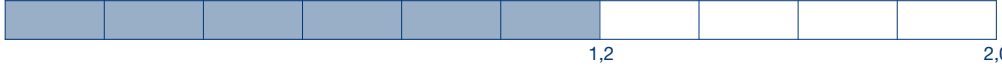









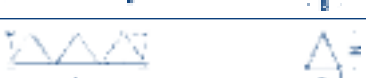









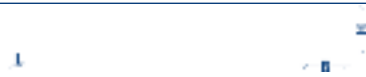



Drive [Type]	Operating speeds Load capacity	Hook travel max. [m]	Power rating [kW]
<b>HFU 45-40</b>	<b>Hoisting</b>	<b>210</b>	<b>45</b>
	 <p>Continuous acceleration</p>		
	<b>Hoisting</b>	<b>320</b>	
	 <p>Continuous acceleration</p>		
<b>Hoisting</b>	<b>640</b>		
	 <p>Continuous acceleration</p> <p><small>*(referring to the 3rd layer on the hoist rope drum)</small></p>		
<b>WW</b>	<b>Luffing</b>		<b>45</b>
	 <p>Continuous acceleration</p> <p>Operating speeds [m/min] from max. radius to min. radius</p>		
<b>DW</b>	<b>Slewing</b>		<b>2 x 5,5</b>
	 <p>Continuous acceleration</p> <p>Operating speeds [m/min-1]</p>		
<b>Total connected load</b>			
<b>94.0 kVA</b>			
Total connected load at utilisation factor 0.75			

Pos.	Qty.	Description	Package (not to scale)	Length [m]	Width [m]	Height [m]	Weight [kg]	Volume [m³]
1	1	Tower head section complete		5.80	2.42	2.30	8,550	32.28
2	1	Stay rack with ladder, compensor, roller block and stays		12.20	1.70	0.96	4,450	19.91
3	1	Cab with fixing		2.42	1.70	2.45	1,100	10.09
4	1	Counterjib compl. with roller block, luffing and hoist gear		6.32	2.44	2.59	12,200	39.94
5	1	Jib section 1		12.66	1.50	1.60	2,410	30.38
6	0-1 *	Jib section 2		12.64	1.50	1.82	1,860	34.51
7	0-1 *	Jib section 3		12.64	1.50	1.82	1,870	34.51
8	1-2 *	Jib section 4		6.43	1.50	1.60	1,030	15.43
9	1	Jib section 5		12.71	1.50	2.00	2,020	38.13
10	1	Load hook		1.08	0.30	1.15	628	0.37
11	1	Stay fork 1540mm		1.74	0.20	0.20	80	0.07
12	1	Jib stay 1540mm		1.74	0.10	0.20	55	0.03
13	1	Jib stay 3160mm		3.36	0.10	0.20	90	0.07
14	5	Jib stay 6240mm		6.44	0.10	0.20	150	0.13
15	2	Stay rack stays		10.92	0.16	0.24	306	0.42
16	1	Cab platform, Stay rack platform 1 + 2 and platform frame 1 - 6		2.15	2.54	2.54	879	13.87
17	1	Railings (loose parts)		2.20	1.10	0.74	372	1.80
18	1	Steel counterweight 1		0.15	1.90	1.90	4,260	0.54
19	2	Steel counterweight 2		0.15	1.90	1.90	4,340	0.54
20	4	Concrete counterweight		0.57	1.90	1.90	5,000	2.06

\* Quantity depending on jib length

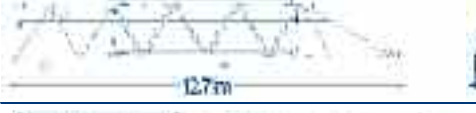
## Transport units

Pos.	Description	Package (not to scale)	Weight [kg]	Volume [m <sup>3</sup> ]
A	<b>Transport unit 1</b> 37.5m jib (jib 1, jib 2, jib 3), stay rack and minor items		9,833	104.07
B	<b>Transport unit 2</b> 22.5m jib (2 x jib 4, jib 5), jib stays		4,935	58.34
C	<b>Transport unit 3</b> Counter jib compl. with cab, tower head section, compl., load hook, platforms		21,773	75.33

**WILBERT Turmkrane GmbH**

Lohrgraben 2  
55444 Waldlaubersheim  
Germany

Phone: +49 (0)6707 6668-0

Fax: +49 (0)6707 6668-1490

Web: [www.wilbert.de](http://www.wilbert.de)

Email: [info@wilbert.de](mailto:info@wilbert.de)

presented by: